

# Console Specifications



KONICA MINOLTA

WIRELESS DIGITAL RADIOGRAPHY SYSTEM

# AeroDR3

## 1417SL

### Control Station CS-7



<b>Image processing</b>	Auto-gradation processing, Frequency processing (F processing), Equalization processing (E processing), Hybrid processing (HF processing - HE processing), Hybrid smoothing processing (HS processing) REALISM processing, Grid removal processing, Automatic exposure field recognition processing, Tube and Gauze image enhancement (option), Intelligent Grid (option) Positioning accuracy judgment (option) Right / left error detection (option)
<b>Image output</b>	Host : max 4 ch / Printer : max 2 ch
<b>DICOM support</b>	DICOM Storage SCU, DICOM basic Grayscale Print Management SCU, DICOM Modality Worklist Management SCU, DICOM Modality Performed Procedure Step SCU, DICOM X ray Radiation Dose SR Storage SCU, DICOM Storage Commitment SCU DICOM Grayscale Softcopy Presentation State Storage SCU, DICOM Verification SCU DICOM X-Ray Radiofluoroscopic Image Storage SCU
<b>Readable devices</b>	AeroDR detector REGIUS MODEL 170, REGIUS MODEL 190, REGIUS MODEL 210, REGIUS MODEL 110 REGIUS MODEL 110HQ, REGIUS SIGMA, REGIUS SIGMA2
<b>Option</b>	Aero Storage (option)

### All-In-One Workstation ImagePilot



<b>Image processing function</b>	Integral Processing, Automatic Processing, Parameter Study
<b>Viewer function display</b>	Grayscale, Window Change, Pan, Zoom, Magnifying Glass, Cine, Comparison Display
<b>Viewer function measurement</b>	VHS, Ratio of heart and chest, 2 Points Distance, 3 points Angle, Cobb Angle, Rectangle area, Ellipse area, Polygon area
<b>Viewer function annotation</b>	Line, Rectangle, Circle, Ellipse, Freehand, Text
<b>Offline image link</b>	Media Input / Output (PDI, DICOM, JPEG, Bitmap)
<b>Software features</b>	Patient Registration, Image Acquisition, Automatic Image Processing with Learning Function Image Review - including magnification, annotations, measurements, layout and window leveling tools Export JPEG images to Media (CD, DVD and USB drive) Export DICOM images to CD/DVD with DICOM PDI format and optional PDI Viewer Import DICOM or JPEG images from Media (CD, DVD and USB drive) Windows printing on paper HL7, ADT and ORM
<b>DICOM support</b>	DICOM Storage SCU, DICOM STORAGE SCU, DICOM basic Grayscale Print Management SCU, DICOM Grayscale Softcopy Presentation State Storage SCP / SCU, DICOM Modality Worklist Management SCU / Detached, DICOM Modality Worklist Management SCU DICOM Q/R SCP/SCU
<b>Readable device</b>	AeroDR G1 / G2, AeroDR3 1012HQ, AeroDR3 1417SL, AeroDR NS1417 REGIUS MODEL 170, REGIUS MODEL 190, REGIUS MODEL 210, REGIUS MODEL 110, REGIUS MODEL 110HQ, REGIUS SIGMA, REGIUS SIGMA2



KONICA MINOLTA, INC. 1 Sakura-machi, Hino-shi, Tokyo 191-8511, Japan  
<https://www.konicaminolta.com/global-en/healthcare/>



RETHINK WHAT'S POSSIBLE

Giving Shape to Ideas

Let's start with AeroDR 3 SL.  
Toward a glass-free and flexible world.



**AeroDR 3 1417SL**

Glass-free TFT substrate  
adopted

Lightweight 1.8kg  
※includes battery

High DQE 59%

Where can the true value of the glass-free lightweight DR detector  
with high image quality be demonstrated?  
We believe it should be demonstrated at the bedside or in the operating room,  
where the handling of the panel is important in mobile X-ray.

Konica Minolta proposes new AeroDR3 SL along  
with various optional functions that are useful in mobile scenes.

There are places where lightweight panels should be used.  
Glass-Free, The best choice for the Mobile X-ray.

**Image Quality**

The combination of high DQE and  
REALISM processing provides high  
quality image.

**Excellent Handling**

Glass-free light weight and  
easy-to-hold body design can  
support exposure.

**Panel Roaming**

A single DR detector can be  
easily shared with Rad rooms  
and mobile X-ray.

**AeroLink**

Mobile radiography enabled by a  
simple configuration.

**Aero Storage**

A convenient function when you  
want to quickly take images.

**Intelligent Grid**

Gridless mobile radiography is  
allowed, making the panel lighter.

# Glass-free design for supreme lightness

## Adoption of glass-free TFT substrate

The previous AeroDR series used a TFT substrate made of glass material, which posed a problem in terms of lighter weight. For the current AeroDR3 1417SL, Konica Minolta adopts its first TFT substrate made of thin film, and together with a review of the internal structure, has succeeded in significantly reducing weight.

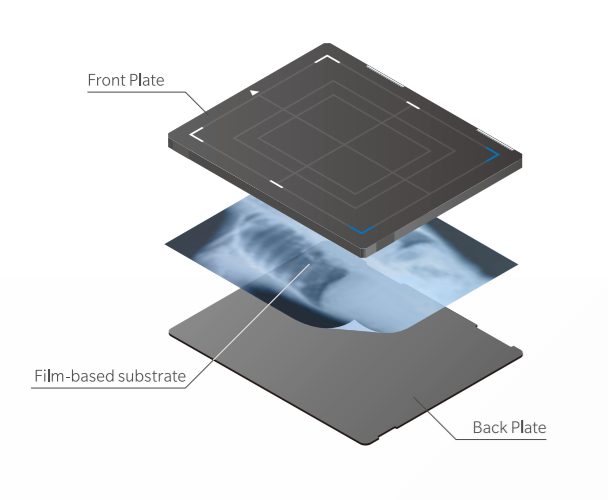

## Realization of a lightweight body that surpasses that of CR cassette

By adopting a glass-free TFT substrate and reviewing the internal structure, the AeroDR3 1417SL has achieved an ultra-light weight of 1.8kg (4.0lb) including the battery. The lightness far surpasses that of CR cassette, greatly reducing the operator's workload in cassette exposure using mobile X-ray.



Lighter than a CR cassette, the detector can be easily handled by one hand.

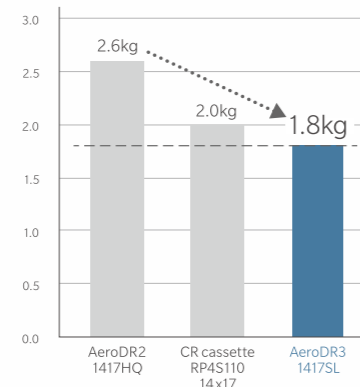
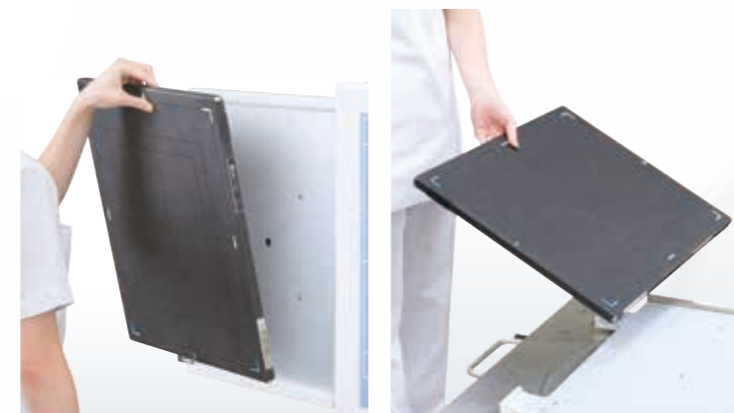

# Easy handling that gives a sense of lightweight

## Grip design for easier handling

The 4mm depression is provided all around the backside panel surface to make it easier to hold the detector. This excellent design allows your fingers to easily latch onto the panel from any direction, and helps your grasp.



## Easy grasping for users in all situations

An easy-to-grasp panel helps support the operator's work in a variety of X-ray examination situations. It can reduce the stress of operators who may experience a feel of fatigue after use or an anxiety of dropping the panel.



# Light and tough. Relentless pursuit of robustness

## Super monocoque housing structure

Carbon SMC (Carbon Sheet Molding Compound) is used for exterior materials. The housing is complex in shape but seamless in structure, lightweight yet highly rigid, and durable enough to meet the demands of the medical field.

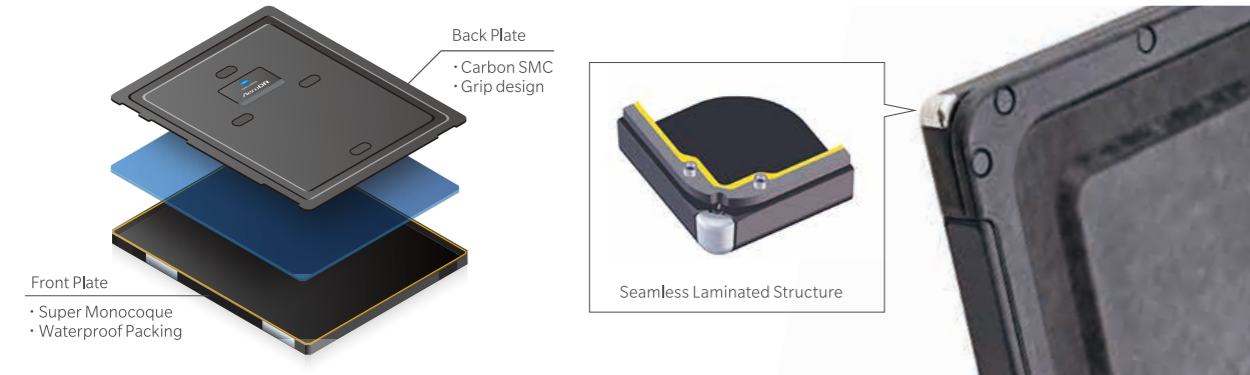

## Patient-friendly round shape

The body shape is designed to prevent pain when inserting the detector into the patient's back for portable radiography.



## Having cleared MIL-STD-810H drop strength test

The AeroDR 3 also has excellent drop impact resistance. It has cleared the US Department of Defense MIL-STD-810H drop strength test, which measures the shock resistance of the panel when dropped.

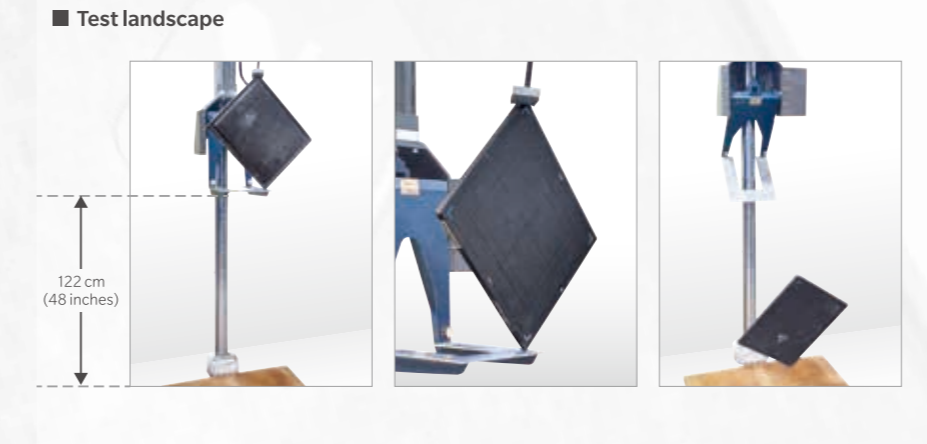

## Antibacterial carbon enclosure

An antibacterial material containing Ag (silver) is kneaded into the enclosure material of AeroDR3 1417SL. The antibacterial agent is evenly dispersed in the material in the thickness direction. Antibacterial property is not lost due to scratches in daily use.

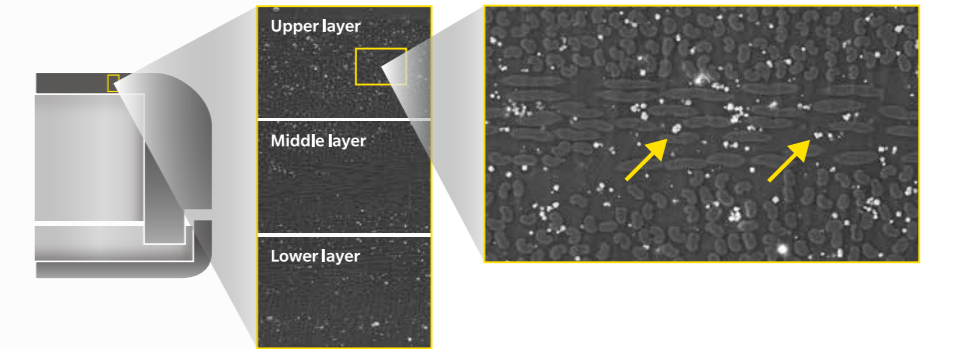

## Evolving carbon body

Each generation of the AeroDR uses a carbon body that has evolved to meet the needs of the times to pursue lightweight, robustness, and easy grasping.



## Compliant with IP56 waterproof/dustproof standard

Compliant with the IP56 waterproof/dustproof standard. By adopting a structure where a packing is inserted between the front and back exterior plates, it is easy to maintain the waterproof structure even when subjected to shocks such as drops.



## Reliable load bearing performance

The layout in the housing structure has been optimized for every load situation. The detector is equipped with a high load capacity to withstand various examination scenes.

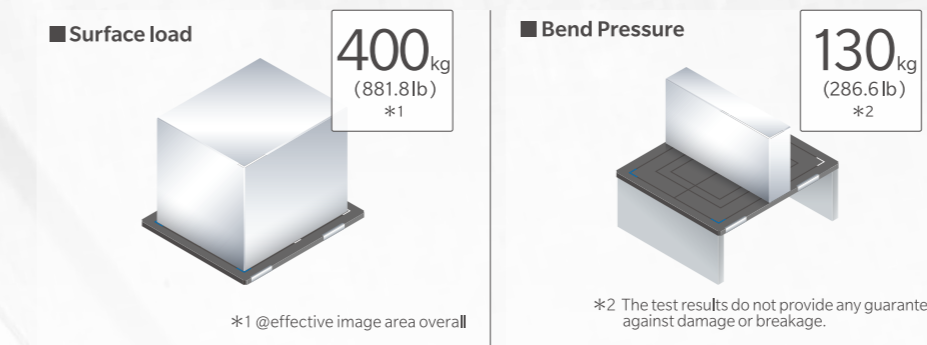

※ The test results do not provide any guarantee against damage or breakage.

## Durability against high-concentration disinfectant solution

As a disinfectant solution for the AeroDR 3 detector, up to 1% concentration of sodium hypochlorite solution can be used. The body surface shows no deterioration even when using a high-concentration disinfectant solution to wipe soil of patient's blood or urine.

- <Available disinfectant>
- Ethanol for disinfection
  - Isopropanol for disinfection
  - Commercial chlorine bleach, or 1% Hypochlorite (5-fold dilution of household bleach)



# Light weight and high image quality. More premium quality sought in images

## High resolution 100/200 μm pixel size

The AeroDR3 1417SL offers the world's smallest pixel size of 100 μm. Its binning process allows you to use either 100 μm or 200 μm depending on your radiography protocol.

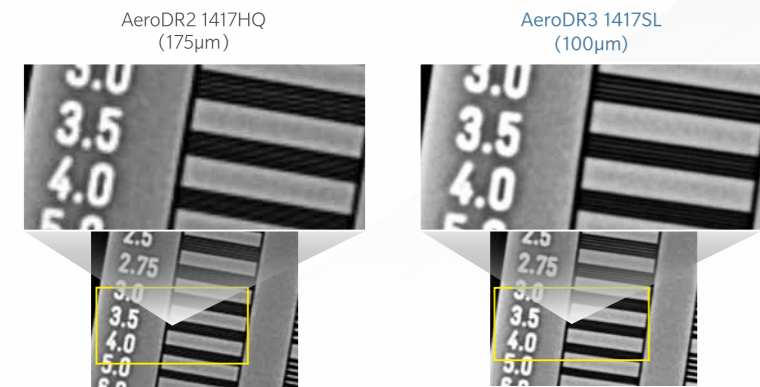
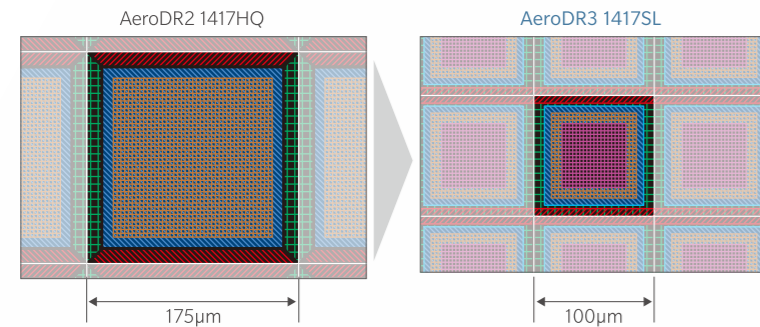

※ AeroDR3 1417SL can read 100 μm for CS-7 by adding an optional license.

## Achieving DQE 59% (1mR, 1cycle/mm)

The AeroDR3 1417SL realizes high resolution and achieves DQE 59% (1mR, 1cycle/mm). In addition to technologies including improved scintillator and electrical noise reduction, the internal structure on the X-ray incident side has become thinner due to the glass-free TFT substrate, thereby reducing the loss of X-ray dose reaching the scintillator. As a result, high DQE is achieved even though the resolution is higher than that of conventional models.

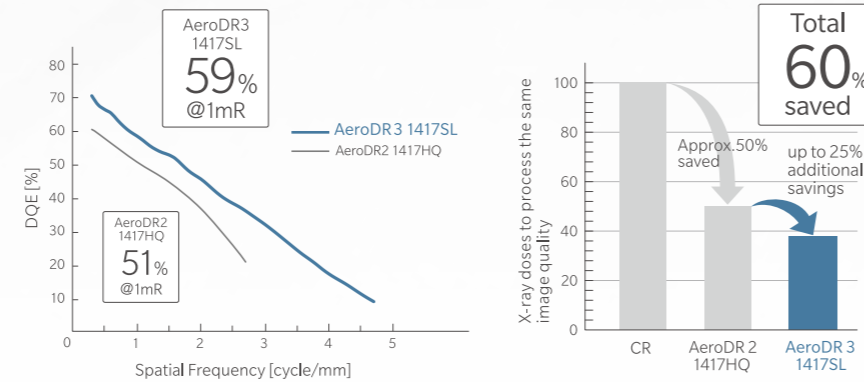
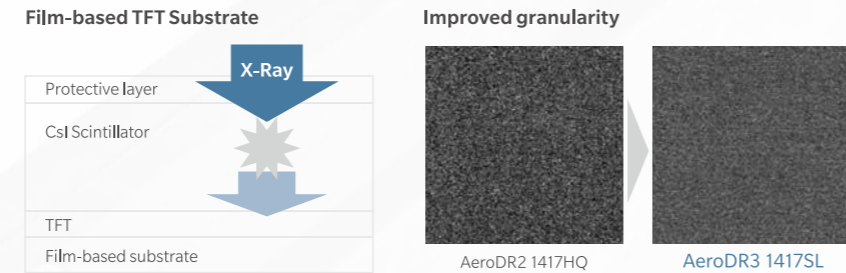

# Image Processing Engine "REALISM" for AeroDR3

"REALISM" is an image processing engine developed to maximize the image quality performance of AeroDR3 with high resolution pixels and high DQE. Thanks to its improved frequency enhancement processing, it can more faithfully depict both low and high frequency regions, and realistically produce images of fine structures such as bone trabeculae and of thick body parts (low-dose regions).



## Increased sharpness to maximize resolution

With optimized 100μm imaging and improved frequency enhancement processing, high-frequency regions are faithfully depicted. This high-resolution imaging realizes the expression of fine structures.

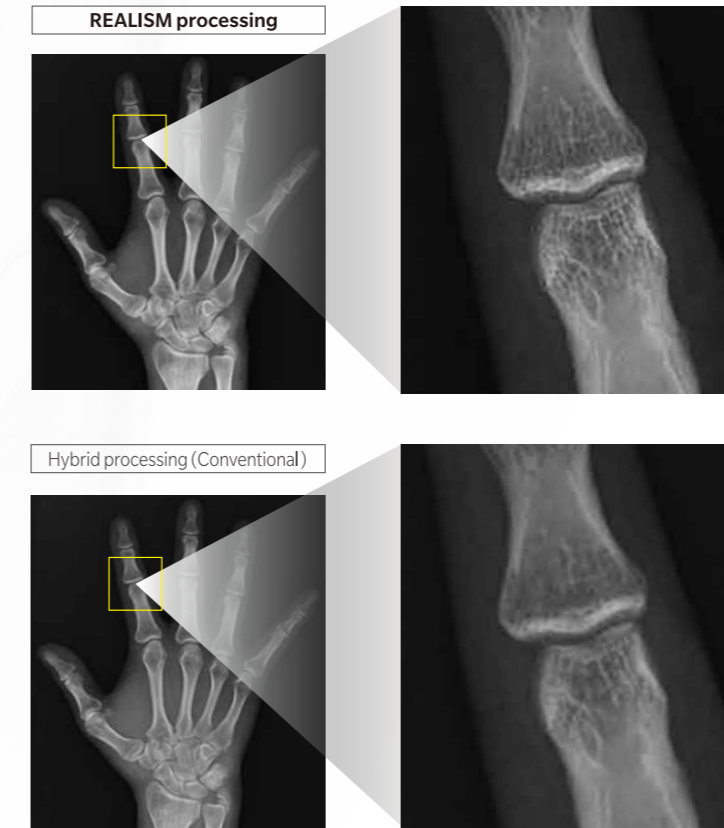

※ AeroDR3 1417SL can read 100 μm for CS-7 by adding an optional license.

## Maintaining contrast while depicting the whole image more clearly

With improved dynamic range compression processing and newly introduced LUT, stereoscopic images are provided by expressing individual structures from low-dose to high-dose regions.

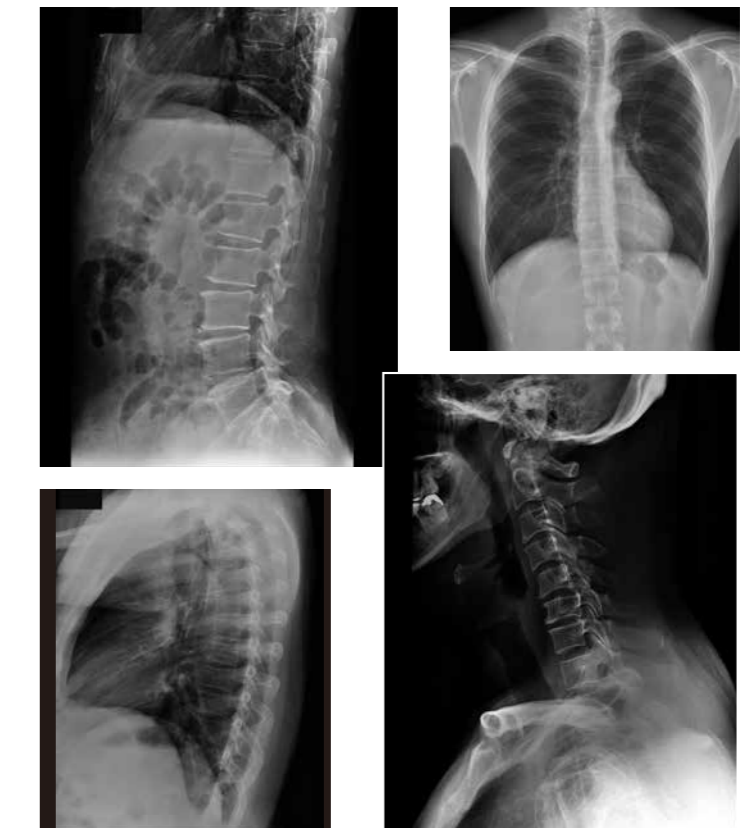

# Various functions to support Mobile x-ray

## AeroDR3 Panel Roaming

The roaming function for sharing the AeroDR detector among multiple X-ray rooms has evolved. Roaming can be easily set with a simple button operation on the detector side. The backup of the detector between X-ray rooms and the sharing of the detector with mobile devices enable more efficient panel operation.

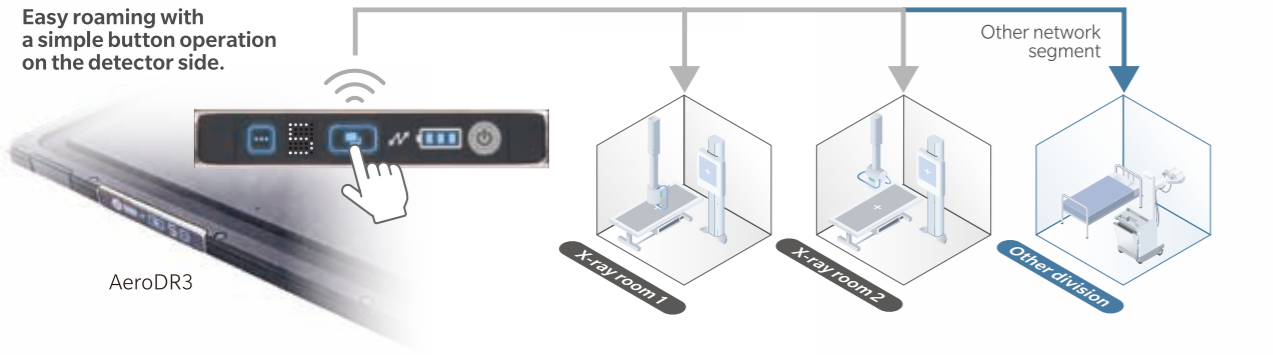

※ This function can be used only for CS-7.

## Aero Storage

Equipped with the Aero Storage function that enables mobile X-ray imaging on the detector alone. Up to 100 images can be stored inside the detector and easily exported to the CS-7 console after performing radiography to match them with patient information. When combined with the optional Mobile Terminal, the detector's status and captured image previews can be checked at hand. This solution is ideal for users who want to speedily take small volumes of images.

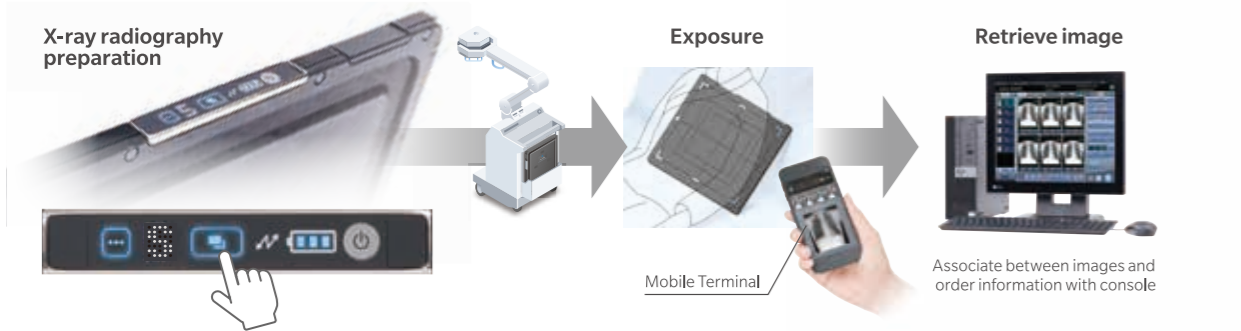

※ This function is optional for AeroDR3 1417SL. It can be used with a license sold separately.

## AeroLink

AeroLink enables AP-less connection between the console and AeroDR detector. Any console can be combined with any detector. It is also possible to switch between multiple detectors according to the purpose of radiography.

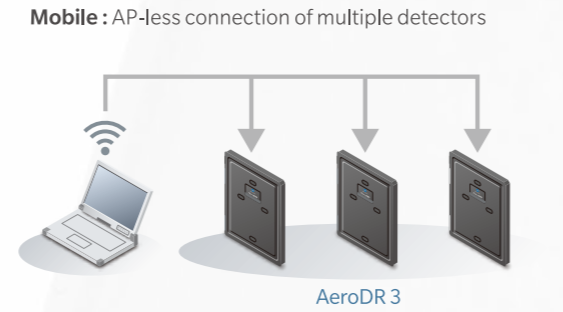

Equine : AP-less realizes a simple configuration



※ This function can be used only for CS-7.

## Intelligent Grid

Intelligent Grid is an image processing technology that improves image contrast by removing the effects of scattered radiation through image processing. It allows users to obtain high quality gridless images for mobile radiography.

Target body part for Intelligent Grid

Without Grid

With Intelligent Grid

The image quality processed by 'Intelligent Grid' is not guaranteed to be same as the image quality obtained by using a grid.

<Target Areas>  
 Head (PA/AP, LAT, towne) / Acoustic organ / Neck (PA/AP, LAT, oblique) / C-Spine (PA/AP, LAT, oblique) / Chest (PA/AP, LAT) / T-Spine (PA/AP, LAT) / L-Spine (PA/AP, LAT, oblique) / Abdomen (PA/AP, LAT) / Cystography / Finger bone / Tarsal bone / Phalanges / Toe bone / Ped. Chest (PA/AP, LAT) / Infant (chest and abdomen) / Newborn (chest and abdomen)

※ CS-7 Optional license is necessary to use this function

## Tube and Gauze Image Enhancement

This image processing is specially designed to make it easier to check the remaining objects in surgical imaging and to confirm the position and route of the catheter tip. Objects that are difficult to detect with normal image processing can be highlighted.

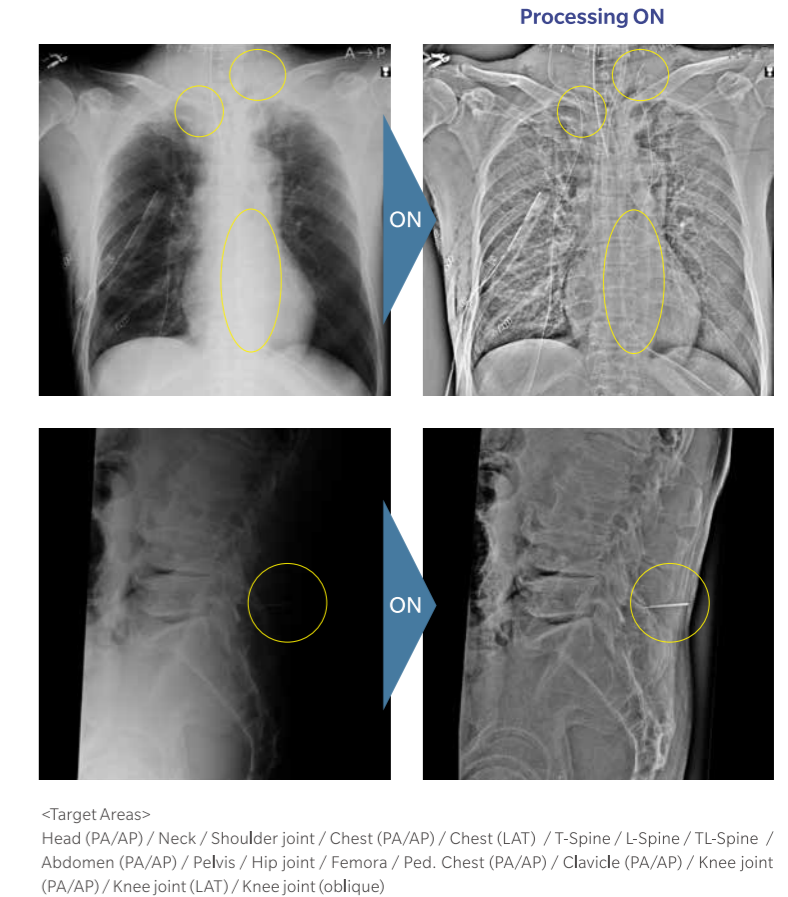

※ CS-7 Optional license is necessary to use this function

# Control Station CS-7

CS-7 is a DR/CR console optimized for radiography workflow. Multiple DR or CR devices in an X-ray room can be controlled by the single console to acquire patient information from the HIS/RIS in the hospital and send captured images to PACS and printers. With its fast preview display and cycle time, along with a variety of image adjustment functions, it is the ideal console for facilities that take many radiographs.

## Integrated Console

By connecting to various systems within the hospital, a seamless exposure environment can be created.

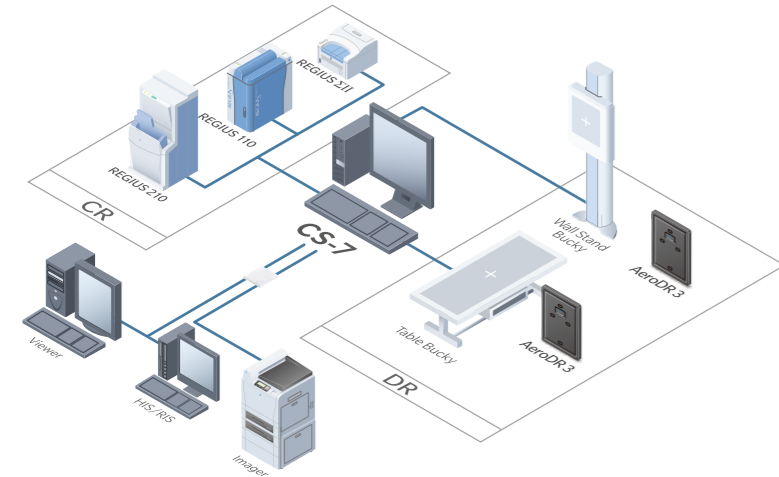

## Setup to suit your needs

CS-7 can be set up not only on a desktop PC but also on a mobile PC. It can also be used in combination with an analog mobile to digitally upgrade exposure in an operating room or at bedside.

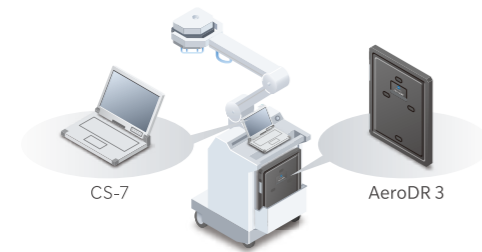

## "Positioning-i" to support positioning judgment

AI\* supports general radiography operations. Two positioning judgment support functions help reduce the number of re-radiography shots and improve operational efficiency.

### Positioning accuracy judgment

AI detects the amount of misalignment at key positioning points and supports the judgment for re-radiography.



Realizes standardization of re-radiography criteria and reduction of decision-making time.

### Right/left error detection

AI detects inconsistencies between the order information and the image, preventing right/left errors on the part of the patient.



Prevents diagnosis with images that differ from the order.

\* Deep learning, an AI technology, was employed in the design. The performance and accuracy of this function will not automatically change after installation. When a judgment result is displayed by the positioning judgment support function or the right/left judgment support function, be sure to check the image before re-radiographing.

# All-In-One Workstation ImagePilot

ImagePilot is an All-In-One Workstation that integrates DR/CR console functions with Mini-PACS functions. Its Integral processing automatically optimizes exposed body parts, and the Mini-PACS function supports multiple modalities. From patient registration to exposure, image viewing, and image storage, this system provides a one-stop solution suitable for small facilities.

## Just 2 steps!

X-ray examination is completed in just two steps: patient information registration and exposure. The images can be viewed immediately on the monitor.

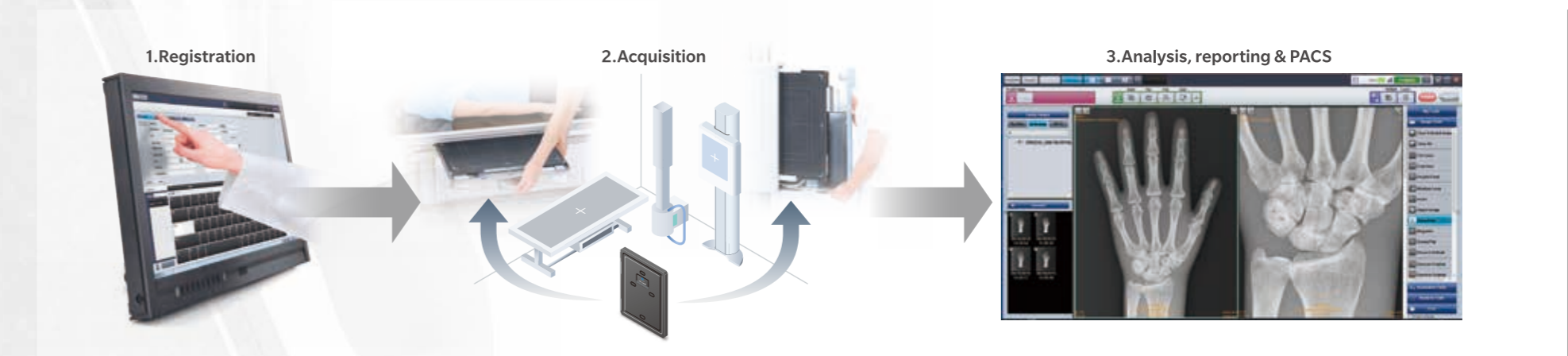

## Centralized management of examination images

Online connection with DR/CR and ultrasound devices, and import of digital camera images are possible. This allows you to centrally manage examination images generated in the hospital.

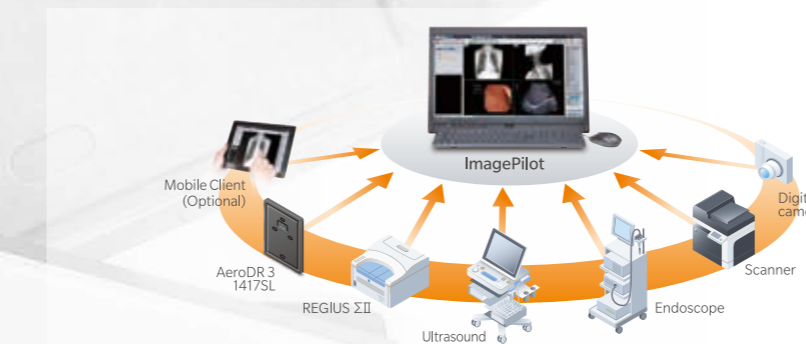

## Various viewing functions

Various functions for viewing images on the monitor are provided. With the introduction of ImagePilot, filmless operation can be easily achieved.



# AeroDR3 accessories

## AeroDR Battery Charger2

<b>Power</b>	AC 100 / 110 / 115 / 120 / 200 / 220 / 230 / 240 V ± 10% Single Phase 50 / 60 Hz
<b>External dimensions ( W×D×H )</b>	474.2×200×206.7mm (18.7×7.9×8.1 inches)
<b>Weight</b>	6kg (13.2 lb)



## Power Supply Unit

<b>External dimensions ( W×D×H )</b>	185×105×150mm (7.3×4.1×5.9 inches)
<b>Weight</b>	2.0kg (4.4 lb)
<b>Power requirements</b>	AC 100–240 V±10% Single phase 50/60 Hz
<b>LAN interface</b>	3 ports



## Detector Interface Unit

<b>External dimensions ( W×D×H )</b>	60×130×22mm (2.4×5.1×0.9 inches)
<b>Weight</b>	0.3 kg (0.7lb)
<b>Power requirements</b>	AC 100 V-240 V ±10 %, single phase, 50/60 Hz
<b>LAN interface</b>	1 port



## Interface Cable 3

<b>Length</b>	8m (315 inches)
<b>Weight</b>	1.0 kg (2.2lb)

## Generator Interface Unit3

<b>Power requirement</b>	When the AC adaptor is used : Supplied from the dedicated AC adaptor. When the Power Supply Unit is used : Supplied from the Power Supply Unit via the Ethernet cable.
<b>Power Supply when using the dedicated AC adaptor</b>	AC 100V–240V ± 10%, Single phase, 50/60 Hz
<b>Power consumption when using the dedicated AC adaptor</b>	Approx. 72VA (100-240V)
<b>External dimensions ( W×D×H )</b>	195×150×43 mm (7.7×5.9×1.7 inches)
<b>Weight</b>	1.0 kg (2.2 lb)
<b>Dedicated AC adapter specifications</b>	Dimensions : 78×50×35 mm (3.0×2.0×1.4 inches) ※ excluding wall mount & cable Weight : 180g (0.4 lb) Input : AC 100V - 240V 0.6A-0.3A, Single phase, 50Hz - 60 Hz Output : DC 5V, 3A Safety : IEC60601-1 Class II

## System configuration

■ **In-room solution** : It is possible to digitally upgrade your X-ray room without changing the existing X-ray devices. In addition, since the accessories are common to the previous AeroDR3, the system can be easily expanded.

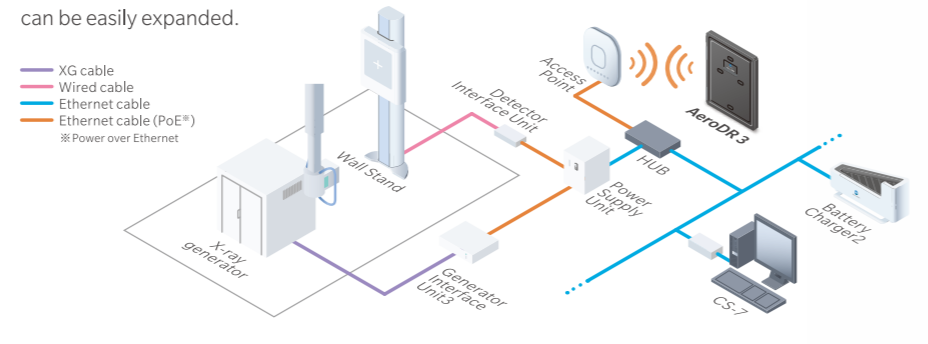

# AeroDR 3 1417SL Specifications

## AeroDR SYSTEM 3 \*3

<b>Product name (model name) *4</b>	AeroDR 3 1417SL (P-82)
<b>Detection method</b>	Indirect conversion method
<b>Scintillator</b>	CsI (Cesium Iodide)
<b>External dimensions (W×D×H)</b>	384 × 460 × 15mm (15.1 × 18.1 × 0.6 inches)
<b>Weight</b>	1.8kg (4.0lb)
<b>Pixel size *5</b>	200 μm (100 μm : optional license is necessary)
<b>DQE 1mR,RQA5 *6</b>	59% (1cycle/mm) 72% (0cycle/mm)
<b>MTF *7</b>	62% (1cycle/mm)
<b>Image area size</b>	348.8 × 425.6mm (13.7 × 16.8 inch) 3,488×4,256
<b>AD conversion</b>	16 bit (65,536 gradients)
<b>Usable grid frequency</b>	60 / 40 / 34 lp / cm
<b>Antibacterial</b>	An inorganic antibacterial agent kneaded into the exterior material.
<b>Communication</b>	Dedicated wired ethernet connection/ Wireless LAN (IEEE802.11a / IEEE802.11n compliant)
<b>W-LAN encryption</b>	Wireless encryption method : AES / Authentication method : WPA2-PSK
<b>Auto Exposure Detection (AED)</b>	Available (AeroSync)
<b>Durability</b>	<b>Surface load *8</b> 400kg@ effective image area overall <b>MIL-STD</b> <b>Waterproof *9</b> IPX6 including power cell <b>Dustproof *9</b> IP5X including power cell
<b>Cycle time *10 (with CS-7)</b>	<b>100μm *5</b> Approx. 6s with dedicated wired connection Approx. 7s with wireless LAN connection <b>200μm</b> Approx. 4s with dedicated wired connection Approx. 4s with wireless LAN connection
<b>Battery performance</b>	<b>Expected product life time</b> Same as the life time of AeroDR 3 1417SL main body <b>Operating time *11 (200μm with wireless LAN connection)</b> Approx. 147 images / 4.1h * Assuming that the AeroDR system is connected to an X-ray system, the interval between studies is 5 min, and three images are captured in each study, and assuming 20s for each exposure to position the patient. <b>Charging time empty to full</b> Within 15 min <b>Maximum stand by time *12</b> Approx. 6.0 h



## Recommended storage and usage environment condition

When operating:  
(Temperature) 10 to 35°C (50 to 95°F)  
(Humidity) 35 to 85% RH (ensure no water condensation)  
(Atmospheric pressure) 700 to 1060 hPa

When not operating:  
(Temperature) -10 to 40°C (14 to 104°F)  
(Humidity) 20 to 90% RH (ensure no water condensation)  
(Atmospheric pressure) 700 to 1060 hPa

In storage / transport :  
(Temperature) -20 to 50°C (-4 to 122°F)  
(Humidity) 20 to 90% RH (ensure no water condensation)  
(Atmospheric pressure) 700 to 1060 hPa

\* However, performance warranty period when storing at 50°C is 6 months after packing.

\*3 AeroDR SYSTEM 3 is the commercial product name of SKR 3000. \*4 AeroDR 3 1417SL is the commercial name of P-82 of SKR 3000. \*5 AeroDR 1417SL can read 100 μm for CS-7 by adding an optional license. \*6 DQE value is typical value. \*7 Typical value at 1x1 binning. \*8 Dead loading does not give affection to processed image or panel. Robustness against loading of AeroDR 3 1417SL is not to provide any guarantees not to be damaged, not to be broken. \*9 The waterproof and dustproof performance of AeroDR 3 1417SL is not to provide any guarantees about perfect water resistance, not to be damaged, not to be broken. \*10 Specifications may vary depending on system that AeroDR 3 1417SL is connected to an X-ray generator. \*11 The specifications assume that 3 exposures are taken within one study and that the time between studies is 5 assumes that the AeroDR 3 1417SL is linked to an X-ray generator and is also connected to a CS-7 image processing workstation. \*12 The specifications described above are based and environment.



★ Specifications are subject to change without prior notice.